

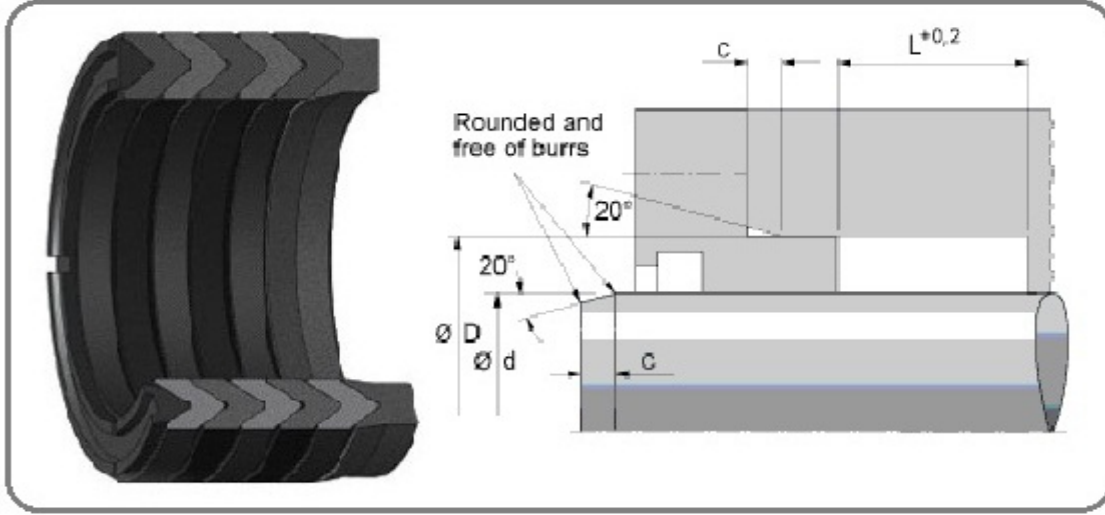







HİDROLİK - BOĞAZ SIZDIRMAZLIK ELEMANI - PACKING - W001

W001 pacingler bir bezli kauçuk arka manşet , bir termoplastik ön manşet , üç adet bezli kauçuk orta manşet ve iki adet kauçuk manşetten oluşur. Özellikle zor koşullarda çalışabilmesi , çabuk montaj yapılabilmesi nedeniyle en çok tercih edilen hidrolik boğaz sızdırmazlık elemanıdır. Demir-çelik endüstrisinde sıkça kullanılır. Ortamda yüksek sıcaklık söz konusu ise BEZLİ VİTON ve PTFE uygulanarak sorun çözülebilir. Çalışma koşullarında 400 bar basınca kadar dayanıklılık gösterir.



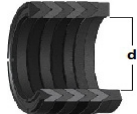

			
W001-008	8	18	18,5
W001-010	10	20	18,5
W001-012	12	22	18,5
W001-013	13,5	25	16,5
W001-014	14	24	18,5
W001-015	15	25	18,5
W001-015/1	15	32	25
W001-016	16	26	18,5
W001-018	18	28	18,5
W001-018/1	18	32	23,5
W001-020	20	30	18,5
W001-020/1	20	32	22,5
W001-022	22	32	18,5
W001-022/1	22	34	22,5
W001-025	25	37	22,5
W001-025/1	25	40	22,5
W001-028	28	40	22,5
W001-028/1	28	43	22,5
W001-030	30	42	22,5
W001-030/1	30	45	22,5
W001-030/2	30	50	37
W001-032	32	44	22,5
W001-032/1	32	47	22,5
W001-035	35	47	22,5

HİDROLİK - BOĞAZ SIZDIRMAZLIK ELEMANI - PACKING - W001

			
W001-035/1	35	50	22,5
W001-036	36	48	22,5
W001-036/1	36	51	22,5
W001-040	40	52	22,5
W001-040/1	40	55	22,5
W001-040/2	40	55	25
W001-040/3	40	56	22,5
W001-042	42	54	22,5
W001-042/1	42	57	22,5
W001-045	45	60	22,5
W001-045/1	45	65	22,5
W001-045/2	45	55	22
W001-045/3	45	62	26
W001-047	47	65	33
W001-048	48	63	22,5
W001-050	50	65	22,5
W001-050/1	50	70	30
W001-055	55	70	22,5
W001-055/1	55	75	30
W001-055/2	55	67	24
W001-056	56	71	22,5
W001-056/1	56	76	37
W001-056/2	56	72	49
W001-060	60	75	22,5
W001-060/1	60	80	37
W001-060/3	60	85	37
W001-063	63	78	22,5
W001-063/1	63	83	37
W001-063/2	63,5	78	40
W001-065	65	80	22,5
W001-065/1	65	85	40
W001-070	70	85	22,5
W001-070/1	70	90	40
W001-075	75	90	22,5
W001-075/1	75	95	40
W001-075/2	75	87	25
W001-075/3	75	100	34
W001-080	80	95	22,5
W001-080/1	80	100	40
W001-085	85	100	22,5
W001-085/1	85	105	40
W001-085/2	85	95	22,5
W001-090	90	105	22,5
W001-090/1	90	110	40
W001-090/2	90	110	26
W001-090/3	90	110	22,5
W001-095	95	120	50
W001-100	100	115	30

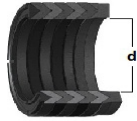
HİDROLİK - BOĞAZ SIZDIRMAZLIK ELEMANI - PACKING - W001

			
W001-100/1	100	120	40
W001-105	105	120	30
W001-105/1	105	125	40
W001-105/2	105	130	40
W001-110	110	125	30
W001-110/1	110	130	40
W001-115	115	130	30
W001-115/1	115	135	46
W001-115/2	115	140	30
W001-120	120	140	49
W001-120/1	120	145	46
W001-125	125	140	34
W001-125/1	125	150	46
W001-130	130	155	42,5
W001-135	135	160	55
W001-135/1	135	160	40
W001-140	140	155	34
W001-140/1	140	165	46
W001-150	150	170	40
W001-150/1	150	180	60
W001-160	160	180	40
W001-160/1	160	190	60
W001-165	165	195	50,5
W001-180	180	200	40
W001-180/1	180	210	60
W001-190	190	220	42
W001-200	200	220	40
W001-200/1	200	230	60
W001-210	210	240	50
W001-215	215	245	41
W001-230	230	260	58
W001-240	240	270	60
W001-240/1	240	260	46
W001-250	250	270	42
W001-260	260	290	60
W001-290	290	320	35
W001-300	300	330	60
W001-310	310	340	60
W001-320	320	350	60
W001-320/1	320	360	46
W001-330	330	360	60
W001-360	360	390	60
W001-360/1	360	400	55
W001-370	370	400	55
W001-400	400	440	65
W001-400/1	400	430	46
W001-420	420	460	80
W001-440	440	480	68
W001-450	450	490	65